

Carrera[®]
DIGITAL 124

Carrera[®]
DIGITAL 132

30342

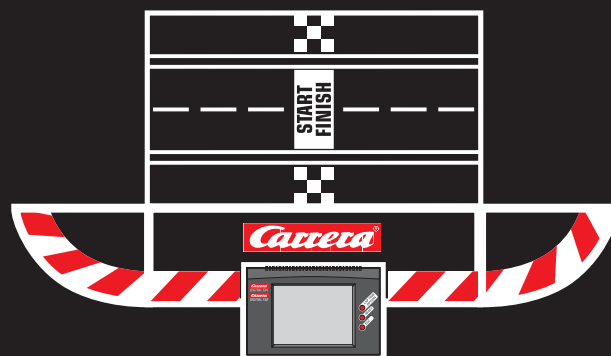

- D** Montage- und Betriebsanleitung
- GB USA** Assembly and operating instructions
- F** Instructions de montage et d'utilisation
- E** Instrucciones de uso y montaje
- P** Instruções de montagem e modo de utilização
- I** Istruzioni per il montaggio e l'uso
- NL** Montage- en gebruiksaanwijzing
- S** Monterings- och bruksanvisning
- FIN** Asennus- ja käyttöohjeet
- N** Montajse- og bruksanvisning
- H** Ósszeszerelési és használati útmutató
- PL** Instrukcja obsługi i montażu
- SK** Návod na montáž a pre prevádzku
- CZ** Návod na montáž a pro provoz
- BG** Ръководство за монтаж и експлоатация
- GR** Μοντάζ και Οδηγία χρήσης
- RO** Instrucțiuni de montaj și de utilizare
- DK** Monterings- og driftsvejledning
- RC** 安装和使用说明
- J** 取扱説明書取扱説明書の内容は予
- ROK** 조립과 작동 방법
- Arabic** إرشادات التركيب و الأستخدام
- TR** Montaj ve işletme kılavuzu
- RUS** Инструкция по монтажу и эксплуатации

Table of contents

Safety instructions	7
Contents of package	7
Important Information	7
Assembly instructions	7/8
Electrical connection	7
Coding/decoding	
of the cars to the according speed controller	8
False start	8
Display and range of functions	8
Training mode	8
Race modes	8
Display Settings	9
Connection PC-Unit	9
Maintenance and care	9
Troubleshooting / Driving tips	9
Technical specifications	9

Welcome

Welcome to the Team Carrera!

These operating instructions contain important information regarding the assembly and operation of your Carrera DIGITAL 124/132 electronic lap counter. Please read them carefully and keep them in a safe place afterwards.

If you have any queries, please do not hesitate to contact our distributor or visit our websites:

www.carrera-toys.com - www.carreraclub.com

Please check the contents for completeness and possible transport damage. The packaging contains important information and should also be retained.

Please take note that the electronic lap counter is only functioning in combination with item 30344 Black Box Carrera DIGITAL 124/132. The lap counter can be used with Carrera DIGITAL 124/132 cars.

Please refer to the Black Box operating instructions should you require information for operating the 30344 Black Box Carrera DIGITAL 124/132.

We hope you will derive a lot of pleasure from your new Carrera DIGITAL 124/132 electronic lap counter.

Safety instructions

• **WARNING!** Not suitable for children under 36 months. Danger of suffocation due to small parts which may be swallowed. Caution: risk of pinching caused by function.

• Regularly check the track and cars for damage to cables, plugs and housings! Replace defective parts.

• The car racetrack is not suitable for outdoor operation or operation in wet locations! Keep away from liquids.

• Do not place any metal parts onto the track to avoid short-circuits. Do not place the track in the immediate vicinity of delicate objects, as these could be damaged by cars hurled from the track.

• Pull the plug before cleaning the racetrack! Only use a damp cloth for cleaning, no solvents or chemicals. When it is not in use, store the track in a dry and dust-protected location, preferably in the original cardboard box.

• Do not operate race track at face- or eye-level – risk of injury due to cars being catapulted off the track.

Contents of package

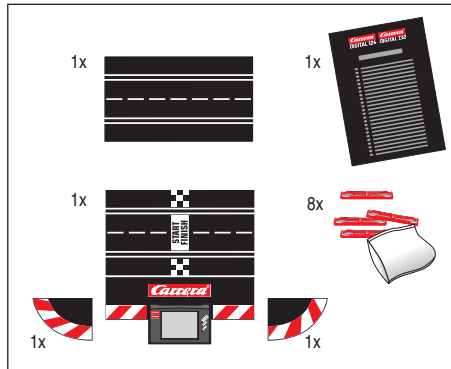

- 1 Standard straight
 - 1 Standard straight with DIGITAL 124/132 electronic lap counter
 - 1 End piece right
 - 1 End piece left
 - 8 Track section interlocks
- Instructions

Please check the contents for completeness and possible transport damage. The packaging contains important information and should also be retained.

Important Information

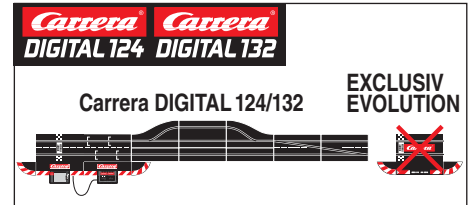

Please note that Exclusiv/Evolution (analog system) and Carrera DIGITAL 124/132 (digital system) involve two separate and completely independent systems. We hereby expressly indicate that both systems must be kept separate when setting up the track, i.e. no connecting rail from Exclusiv/Evolution may be used together with the connecting rail and Black Box of the Carrera DIGITAL 124/132, even if only one of the two connecting rails (Exclusiv/Evolution connecting rail or Carrera DIGITAL 124/132 connecting rail and Black Box) is attached to the current supply. Furthermore, no other Carrera DIGITAL 124/132 components (switches, electronic lap counter, pit stop) may be built into an Exclusiv/Evolution course, i.e. via analog operation.

Non-compliance with the above information may result in damage or destruction of the respective Carrera DIGITAL 124/132 components. In this case no warranty may be claimed.

Assembly instructions

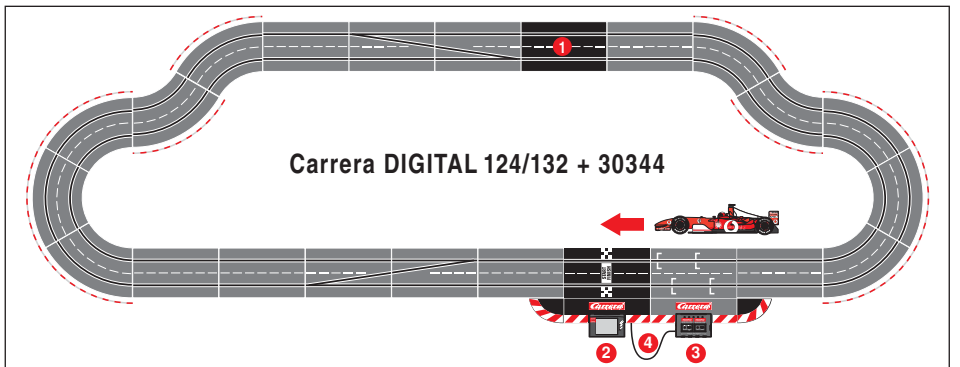

For installation into an existing Carrera DIGITAL 124/132 layout a standard straight 1 is contained in the delivery quantity to make up the distance.

Please note when installing the electronic lap counter 2 that the Black Box 3 must be in immediate proximity in order to attach it to the Carrera DIGITAL 124/132 Black Box (Art. No. 30344) using

a cable connection 4. The electronic lap counter is initialized by switching on the Black Box.

Do not install the electronic lap counter directly after a curve; insert at least one standard straight in front of the Black Box and the lap counter.

Electrical connection

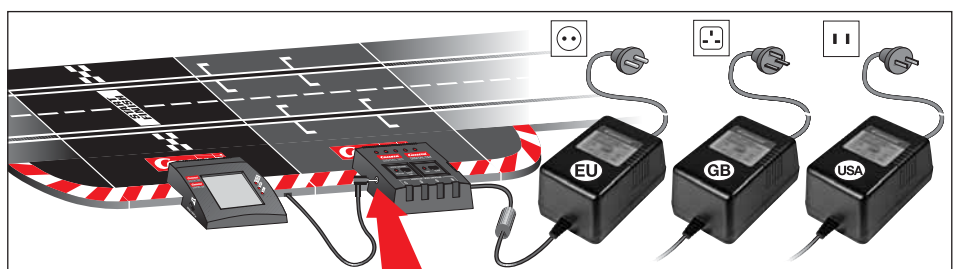

Insert the standard straight with an electronic lap counter Carrera DIGITAL 124/132 into the track layout as illustrated.

Connect the electronic lap counter to the Black Box as shown in the illustration.

Note: To avoid short-circuits and electrocution, the toy may not be connected using foreign devices, plugs, cables or other objects foreign to this toy. The Carrera DIGITAL 124/132 car racetrack only works properly with an original Carrera DIGITAL 124/132 transformer.

Assembly instructions

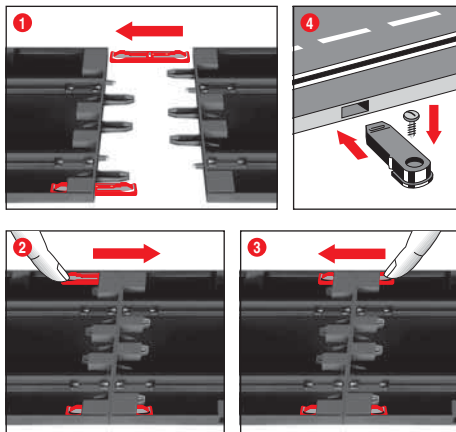

1 + 2 + 3 Before assembling please insert the connecting clips in the track as shown in figure **1**. Stick tracks together on a flat base. Move the connecting clips according to figure **2** in direction of the arrow until they audibly snap in. The connecting clip may also be inserted later. The connecting clips can be removed into both directions by simply pressing down the clamped nose (see fig. **3**).

4 Fastening: To fasten the track sections on a board, it is necessary to use the track section fasteners (Item no. 85209, not contained in the package).

Note:

Carpeting is not a suitable foundation on which to build the track because of static charging, formation of fluff and ready inflammability.

Coding/decoding of the cars to the according speed controller

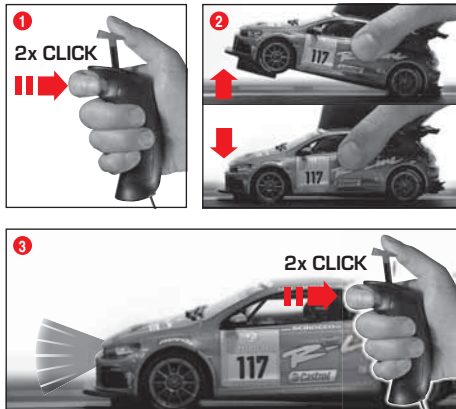

Place car on the track, push lane-change-button twice fig. **1**, lift car at the front, put car back again fig. **2**, while car's lights are flashing push lane-change-button twice fig. **3**. Programming is confirmed by a tone. All settings are saved until new programming is carried out.

False start

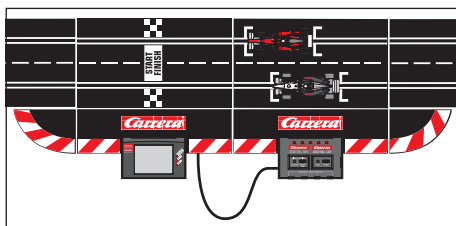

False start: If a car's speed controller is actuated during the traffic light phase, this is rated as false start. The vehicle that has caused the false start will travel a short distance and the LED on the relevant vehicle or hand control will flash. The race is not released and the start has to be repeated.

Display and range of functions

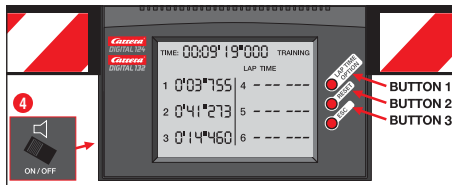
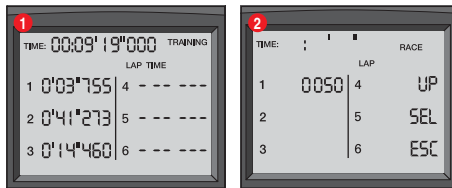

Range of functions

- 1 Training mode
- 2 Lap races possible from 0 – 9999 laps (factory setting 50 laps)
- 3 Time races from 00:00:00'01 – 99:99:99:999 hours (hh:mm:ss'ms) (factory setting 00:05'00"00)

The electronic lap counter Carrera DIGITAL 124/132 disposes of a memory function. Once the values of the factory setting are changed the altered values remain displayed until having been reset.

- 4 Signal tone and fanfare horn may be switched on and off by activating the switch (ON/OFF).

Training mode

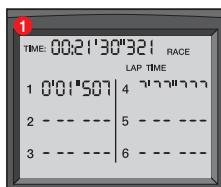

Training mode

The training mode is used for training and the starting positions for the race and can be started without setting the laps or time. The training mode is set as follows:

1. Switch on the Black box (ON/OFF switch).
2. After approx. 1 second the central LED will illuminate permanently and a brief acoustic signal will sound.
3. The Carrera DIGITAL 124/132 electronic lap counter automatically switches on in training mode.
4. Press the start button of the Black Box once – all of the LEDs are constantly lit.
5. Place the pre-coded car/s on the connecting track.
6. Then press the start button again – the starting sequence is initiated, the LEDs are lit and acoustic signals can be heard.
7. The training run begins with elapse of the starting sequence and the overall time ("TIME") and counting begins.
8. The display shows the following information:
 - Allocation of the individual cars (1-6)
 - Total time of training race next to "TIME"
 - Lap time currently driven "LAP TIME"

ATTENTION!

Single lap times exceeding 09:59:999 cannot be displayed, illustration see fig. **1**. This does not affect the total time illustration under "TIME".

While pushing BUTTON 1 during measuring, further information can be retrieved.

- Press "BEST TIME" 1x – best lap time. Only beating the current best time will again be displayed.
- Press "TIME" 2x – displaying the leading car (POS 1) and the other cars' time lag to the leading car
 - < 1 lap: display of time difference "+ m:ss.ms" to the leading car
 - > 1 lap: display of lap difference to the leading car "+ L 00001"
- Press "POSITION" 3x – current positioning of individual cars
- Press "LAPS" 4x – laps already driven
- Press 5x – change back to the current training race

9. For finishing the training race, push BUTTON 3 ("ESC") once during the race. You will return to the main menu (the word "TRAINING" flashes)

Race modes

Racing mode

1. For being able to switch to the racing mode after the electronic lap counter Carrera DIGITAL 124/132 has automatically turned on via the Black Box, please push BUTTON 3 ("ESC").
2. The next display indication allows you to switch between the training- and the racing mode while pushing BUTTON 1 ("CHA").
3. Confirm selection of the racing mode (the word "Race" flashes) by BUTTON 2 ("SEL"), the word "LAP" flashes.
4. You have the choice between **1** lap race and **2** time races.

1 Lap Races

1. If you like to start a lap race ("LAP") please confirm by pushing BUTTON 2 ("SEL").
2. After confirmation you may set the number of laps you like to complete (it is possible to set lap races from 0000 to 9999 laps, factory setting 0050 laps).
3. Basically you have to set the 1's place first, then the 10's place and the 100's place and finally the 1000's place (display cursor flashes on each place). By pushing BUTTON 1 ("UP") you increase the number. In order to change to the next places please push BUTTON 2 ("SEL") and set the value as described. In case the preset number of laps shall not be changed, please confirm by pushing BUTTON 2 ("SEL") until the lap display disappears.
4. After having set the number of laps push the start button of the Black Box once – all LEDs will flash permanently.
5. Place the pre-coded car/s on the connecting track.
6. Then press the start button again – the starting sequence is initiated, the LEDs are lit and acoustic signals can be heard.
7. The lap race starts after the start sequence has proceeded.
8. The total time "TIME" starts to run. Once the leading car has passed through, its total time is displayed and updated upon each passing.
9. The display shows the following information:
 - Allocation of the individual cars (1-6)
 - Total time of the leading car next to "TIME"
 - Lap time currently driven "LAP TIME"

While pushing BUTTON 1 during measuring, further information can be retrieved.

- Press "BEST TIME" 1x – best lap time. Only beating the current best time will again be displayed
 - Press "TIME" 2x – displaying the leading car (POS 1) and the other cars' time lag to the leading car
 - < 1 lap: display of time difference "+ m:ss.ms" to the leading car
 - > 1 lap: display of lap difference to the leading car "+ L 00001"
 - Press "POSITION" 3x – current positioning of individual cars
 - Press "LAPS" 4x – laps still to go
 - Press 5x – change back to the current race
10. As soon as all cars have finished the last lap a signal indicating the end of the race is audible and the display starts to flash.
 11. For returning to the main menu push BUTTON 3 once ("ESC")

1 Time Racing

1. In order to measure the time of a time race please follow steps 1-3 (see lap races).
 2. To start a time race after mode selection lap race ("RACE") push BUTTON 1 ("CHA") for changing from the lap race mode ("LAP") to the time race mode ("TIME").
 3. Confirm selection of time race ("TIME") by BUTTON 2 ("SEL").
 4. After confirmation the seconds' position of the time display will flash (factory setting 00:05:00 min.).
 5. Basically you have to set the seconds first, then the minutes and finally the hours (display cursor flashes on each position). By pushing BUTTON 1 ("UP") you increase the number. In order to change to the next positions please push BUTTON 2 ("SEL") and set the value as described. In case the preset racing time shall not be changed please confirm by pushing BUTTON 2 ("SEL") until the time display disappears.
 6. After having set the requested time for the race push the start button of the Black Box once – all LEDs will flash permanently.
 7. Place the pre-coded car/s on the connecting track.
 8. Then press the start button again – the starting sequence is initiated, the LEDs are lit and acoustic signals can be heard.
 9. The time race starts after the start sequence has proceeded.
 10. The total time "TIME" starts to run backwards.
 11. The display shows the following information:
 - Allocation of the individual cars (1-6)
 - Total time still to be driven "TIME"
 - Lap time currently driven "LAP TIME"
- While pushing BUTTON 1 during measuring, further information can be retrieved
12. After the total time set has expired the race is finished. A signal will be audible and the display starts to flash.
 13. For returning to the main menu push BUTTON 3 once ("ESC")

Display Settings

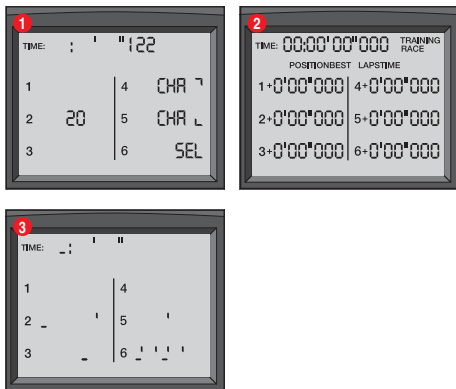

1 Contrast-Setting Display

Switch off Black Box. Keep Button 1 (Lap Time Option) pushed while switching on the Black Box until the display changes according to figure.

Line "TIME" (1) indicates the corresponding software version. The display's contrast can be changed (max. 20) by "CHA" and "CHA L".

2 Display Check

Switch off Black Box. Keep Button 3 (ESC) pushed while switching on the Black Box until the display changes according to figure.

3 Factory Setting

For resetting all data please switch off Black Box. Keep Button 2 (RESET) pushed while switching on the Black Box until the display changes according to figure.

Connection PC-Unit

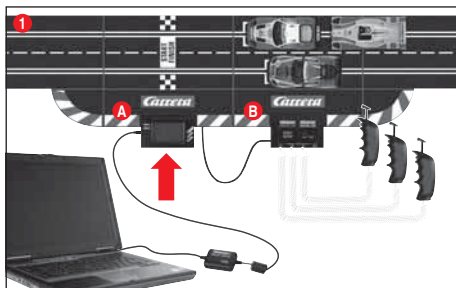

For displaying purposes of your lap counter on a computer we recommend the Carrera DIGITAL 124/132 PC-Unit (item no. 30349). In addition you can manage your own databases for cars and drivers.

Maintenance and care

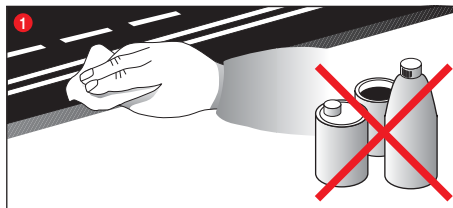

To ensure a proper operation of the motor-racing circuit, all race-track components should be regularly cleaned. Pull the plug prior to cleaning.

1 Racetrack: Keep the track surface and track slots clean with a dry cloth. Do not use any solvents or chemicals for cleaning. When it is not in use, store the racetrack in a clean and dust-protected location, preferably in the original cardboard box.

Troubleshooting Driving tips

Troubleshooting:

In case of any malfunctions, please check the following:

- Has the connection to the power supply been established correctly?
- Have transformer and speed controllers been connected correctly?
- Are the track connections faultless?
- Are the racetrack and track slots clean and free of any foreign objects?
- Are the sliding contacts in order and do they make contact with the track slot?
- Are the cars correctly coded to the according speed controller?
- The track's current feed will be switched off automatically for 5 seconds, if there is an electrical short circuit: this will be notified by audible and visual signals.
- Are the cars placed on the track in running direction? In case of non-functioning push the running direction switch which is on the car's bottom.
- Are the correct guide keels being used and which mode has been selected.
- Insert at least one standard straight in front of Black Box and lap counter.

Note:

During operation small car parts as spoilers or mirrors may get off or brake due to being original detailed parts of the car model. To avoid this it is possible to remove them before operation.

All Carrera spare parts are available in the webshop:

www.carrera-toys.com

Delivery exclusively to Germany, Austria, Netherlands, Belgium and Luxembourg.

Technical specifications

Output voltage · Toy transformer



14,8 V --- 51,8 VA
18 V --- 54 VA



Conforms to the safety requirements of ASTM F963.



This device is marked by "selective sort through" symbol related to sort through domestic, electric and electronic, waste. This means the product must be treated by a specialized "sorting/collecting" system in accordance with European directive 2002/96/CE, to reduce the impact upon environment.

For more precise information, please contact your local administration.

Electronical product which are not going through special collecting, are potentially dangerous for environment and human health, because of dangerous substance.